

PULSAFEEDER®

The Flange Mount Mixer provides a convenient and economical means of mounting smaller mixers. The flange mount allows the mixer to be mounted directly to the tank cover or other flat surface eliminating the need for an additional mixer support. Flange mount mixers are available with 1/3 HP, 115V, open and 1/20 HP, 115V or 230V, TEAO motors. The 1/20 HP flange mount mixer may be mounted directly onto Pulsafeeder solution tanks featuring rigid covers (35 gal - #40365 and 55 gal - #J40366). All mounts are of a one or two piece construction and are held securely to the tank surface by three to four 18/8 stainless steel fasteners which provide ample strength to withstand operational stresses.

Construction

All mixers feature a 304 stainless steel shaft with an integral impeller. Special epoxy and vinyl shaft coatings are available for applications where the solution being agitated is not compatible with 316 stainless steel. The shaft is coupled to the motor via a brass adapter which is held securely by four stainless steel set screws.

All mounting fasteners are 18/8 stainless steel. The mounting flanges may be of stainless steel or steel with a corrosion resistant coating depending on mixer size and configuration.

Installation

Select the proper location on the tank cover. Ensure this location allows proper support of the mixer without allowing the impeller to contact the tank (maintain at least a 3" clearance between the impeller and side wall of tank or any tank bulkhead). Cut or drill the mounting holes and the shaft hole according to the mounting dimensions provided. Place mixer assembly on top of tank and align the holes. Fasten with bolts provided.

Features

- 304 SS Shaft
- Epoxy and Vinyl Shaft Coatings Are Available
- Shafts Cut to Length

Operating Benefits

- Flange mount eliminates the need for additional mixer support.

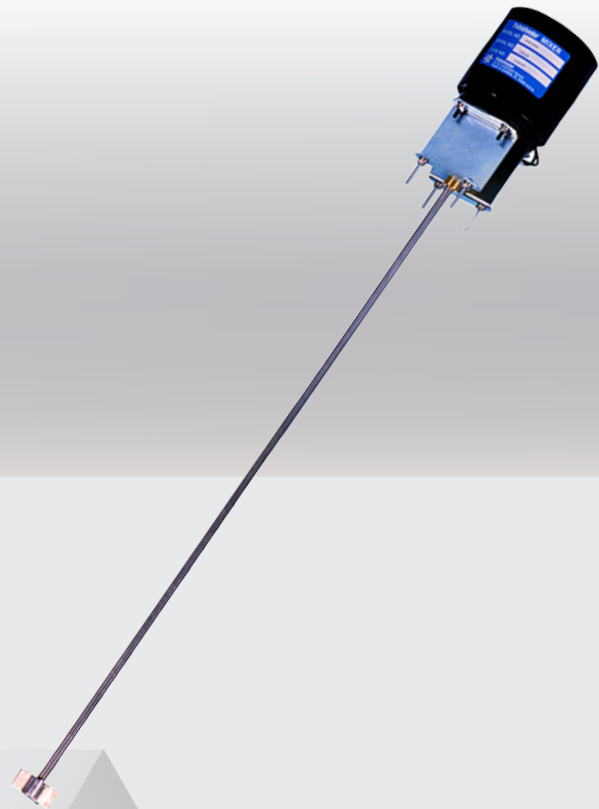

Aftermarket

- Double Wall Containment Tanks from 15 to 500 gallons.
- 1, 2, or 4 Drum Spill Containment Pallets.
- Metering Pumps.



Flange Mount Mixer

Flange Mount Mixer

Specifications and Model Selection

Mixers					
Mount	Motor Type	Model Number	Description	HP	Shaft Length
Flange Mount	Totally* Enclosed Air Open	J64013	115V /Prewired	1/20	24"
		J64027	115V /Vinyl Coated & Prewired	1/20	24"
		42748	115V	1/20	28"
		42753	115V /Prewired	1/20	28"
		42827	230V/50Hz /Prewired	1/20	28"
		42821	115V /Vinyl Coated & Prewired	1/20	28"
		J64017	230V/50Hz /Vinyl Coated & Prewired	1/20	28"
		J42887	230V/60Hz /Vinyl Coated & Prewired	1/20	28"

All Mixers are equipped with 308SS impeller
WHEN MIXING SODIUM HYPOCHLORITE, ORDER VINYL SHAFT COATING.
 No Mixer on 15 gallon Tank. Mixer shafts will be cut to length on request.
 For explosion proof motor consult factory.
 * Use only Tank Model 40365 or J40366 with 1/20 hp Mixers.

Engineering Data

1/ 20 Horsepower

RPM: 1500
 Type: Totally Enclosed
 Voltage: 115 V/ 23V
 Amperage: 1.9 / 0.75
 Motor Design: Split Phase
 Ball Bearing
 Non Ventilated

Alternate Mounts

1/20 HP, 230V, 50 Hz Models:

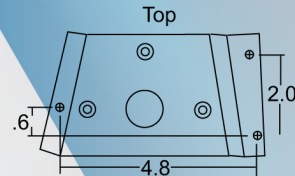
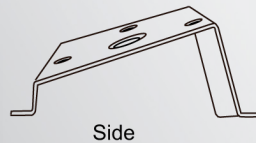

1/3 HP Models:

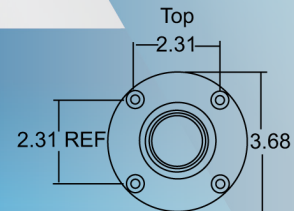
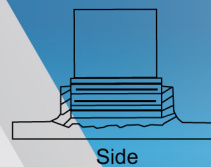

Mount Detail

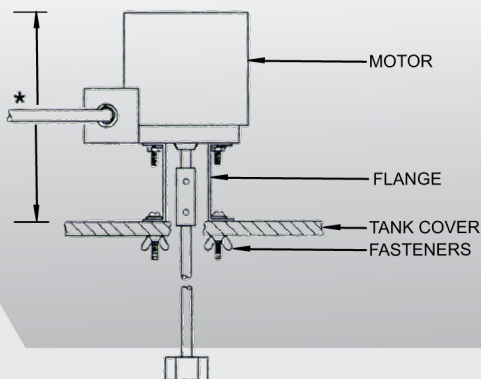

Mounting Dimensions:

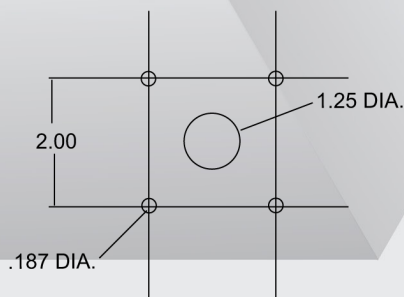

* HEIGHT VARIES WITH MIXER CONFIGURATIONS
 MAXIMUM HEIGHT IS 12"

PULSAFEEDER

27101 Airport Road
 Punta Gorda, FL 33982
 Phone: +1(941) 575-3800
 Fax: +1(941) 575-4085

www.pulsatron.com



An ISO 9001 Certified Company

FMM001 H18

IBEX
 FLUID & METERING